

B A S

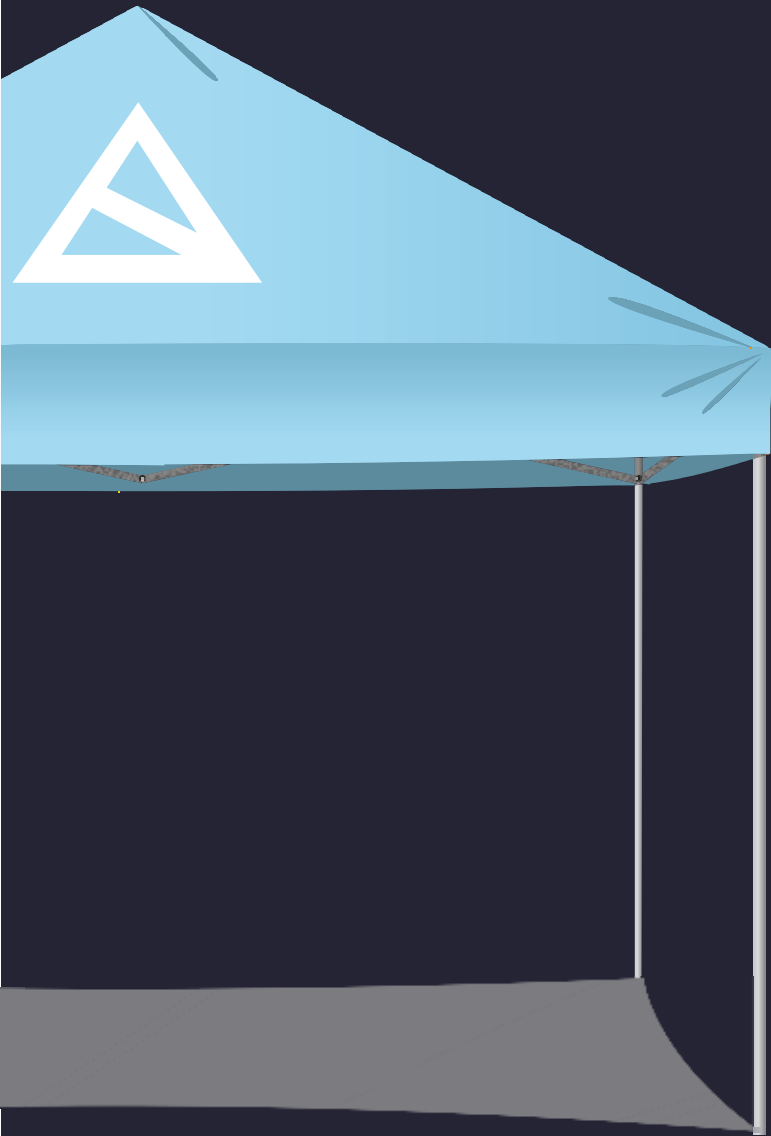

Driven by Innovation



↘ PopUp Aluminium Premium Tent

www.bas-innovation.de

www.bas-innovation.de



PopUp Aluminium
Premium Tent



PopUp Aluminium Premium Tent (AHL)

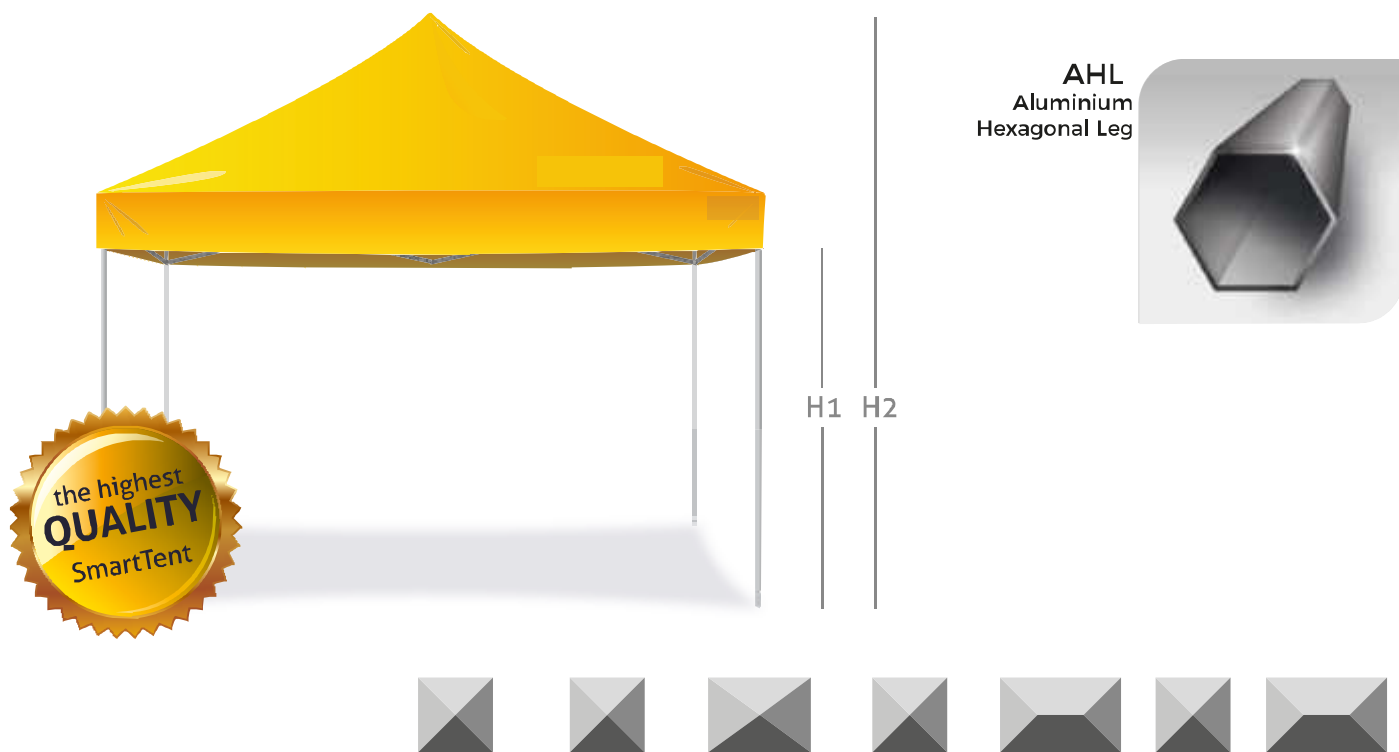

Size	1,5m x 1,5m	2m x 2m	2m x 3m	3m x 3m	3m x 4,5m	4m x 4m	3m x 6m
H1	183cm	183cm	183cm	196cm	196cm	196cm	196cm
H2	260cm	277cm	277cm	388cm	388cm	388cm	388cm

* size and dimensions given refer only to the most common tent specifications. Usually, tent height can be regulated by self-locking system. Please inform BAS-Innovation about any special requirements regarding the tent height before we print the sidewalls.

* Die angegebenen Abmessungen/Höhen sind die Standard Voreinstellungen des Zeltes. Die Höhen können durch ein Druckknopfsystem individuell eingestellt werden. Wenn Sie die genauen Höhen erfahren möchten oder Sonderwünsche diesbezüglich haben, informieren Sie sich bitte bei BAS-Innovation, bevor die Seitenwände des Zeltes in den Druck gehen.

Additional equipment

Zubehör

1. Marquise, Markise
2. Marquise MULTI, Markise MULTI
3. Sidewall MINI, Wände MINI
4. Rain gutter-connector, Regenrinne / Verbinder
5. Tent connector, Zeltverbindungsstück
6. Flag holder, Flaggenhalterung
7. Weight 5kg, Gewicht 5kg
8. Weight 20kg, Gewicht 20kg
9. Tent carry bag with wheels "Professional", Transporttasche auf Rollen "Professional"
10. Pegs, Heringe

B A S



Driven by Innovation

PopUp Aluminium Premium Tent (AOL)

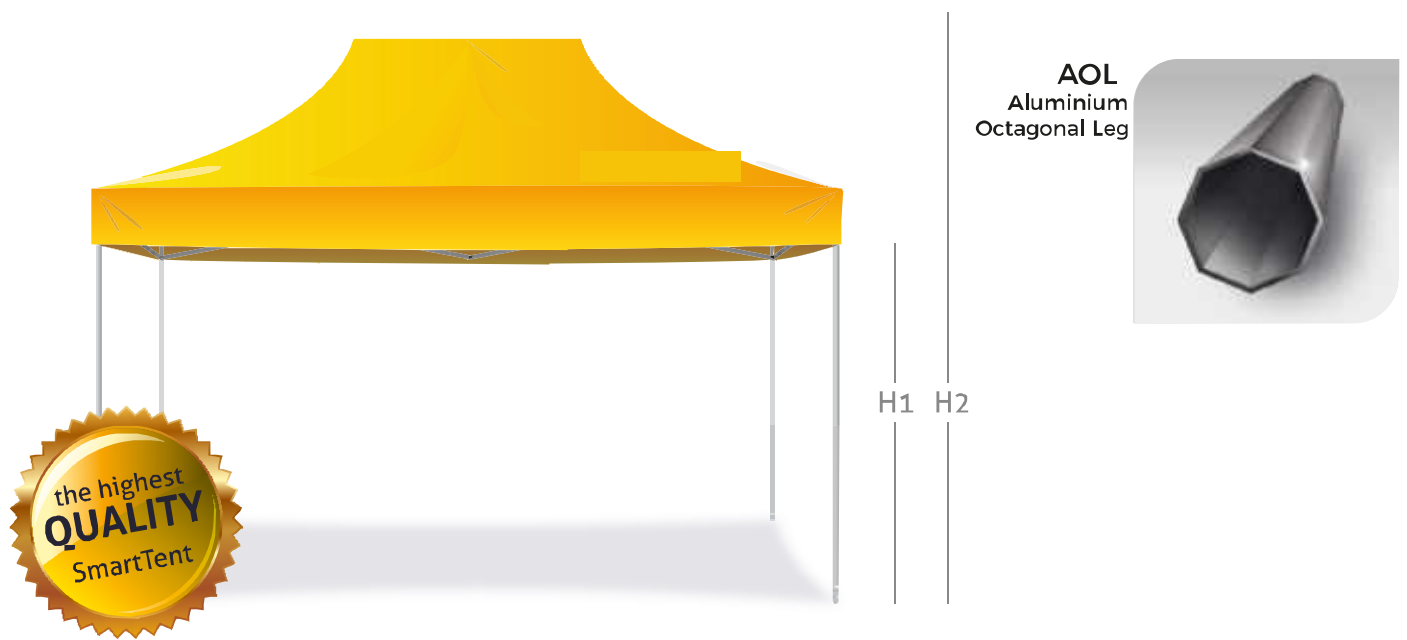

Size	4m x 6m	4m x 8m
H1	200cm	200cm
H2	396cm	396cm

* size and dimensions given refer only to the most common tent specifications. Usually, tent height can be regulated by self-locking system. Please inform BAS-Innovation about any special requirements regarding the tent height before we print the sidewalls.

* Die angegebenen Abmessungen/Höhen sind die Standard Voreinstellungen des Zeltes. Die Höhen können durch ein Druckknopfsystem individuell eingestellt werden. Wenn Sie die genauen Höhen erfahren möchten oder Sonderwünsche diesbezüglich haben, informieren Sie sich bitte bei BAS-Innovation bevor die Seitenwände des Zeltes in den Druck gehen.

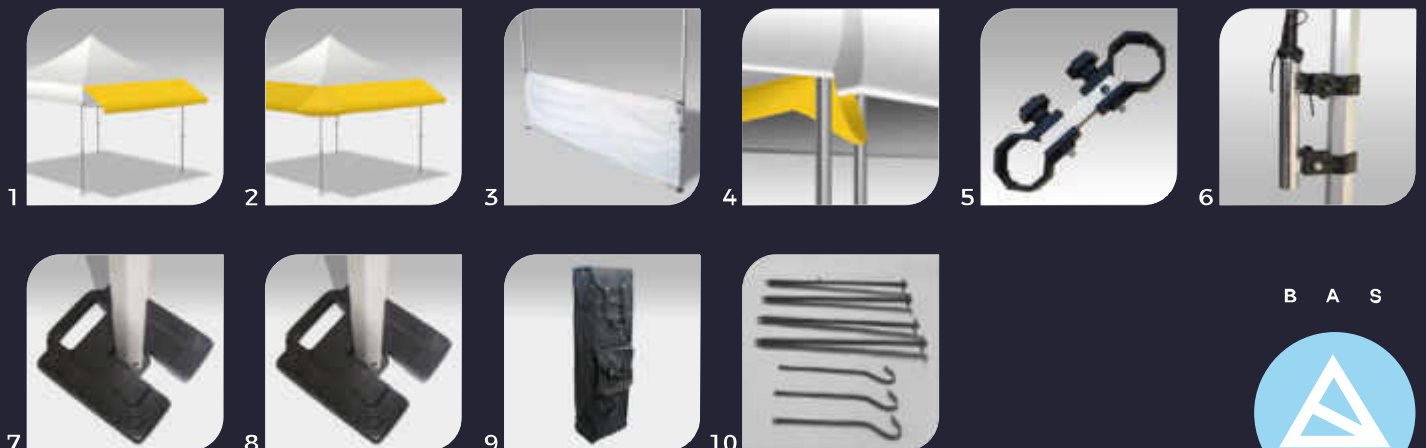

B A S



Driven by Innovation

PopUp Premium (AHL & AOL) tents sidewalls

Wände zu Pop Up Premium Zelten (AHL & AOL)

1,5m					
2m					
3m					
4m					
4,5m					
6m					
8m					
	A	B	C	D	E

PopUp Premium (AHL & AOL) tents sidewalls

Wände zu Pop Up Premium Zelten (AHL & AOL)

1,5m					
2m					
3m					
4m					
4,5m					
6m					
8m					
	F	G	H	I	J

3D PopUp Aluminium Premium Tent (AHL & AOL)

BAS offers with its 3D PopUp tents totally new quality of tents based on PopUp frame (AHL & OHL)
From the combination of instant frame and pneumatic sheathing of the roof we achieved incredibly attractive and unique form of tent. Break the mold and benefit from the possibilities offered to you by our **3D Pop Up TENT!**

NEW



AHL
Aluminium
Hexagonal Leg



AOL
Aluminium
Octagonal Leg

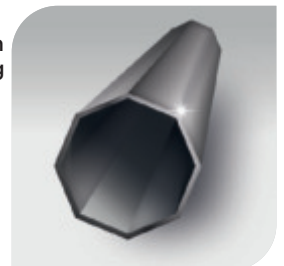

B A S



Driven by Innovation



Flat Roof Tent (AHL & AOL)

NEW



AHL
Aluminium
Hexagonal Leg

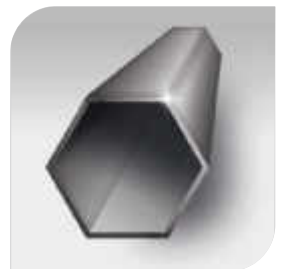

AOL
Aluminium
Octagonal Leg



B A S



Driven by Innovation

PopUp Aluminium Hexagonal Tent (AHL)

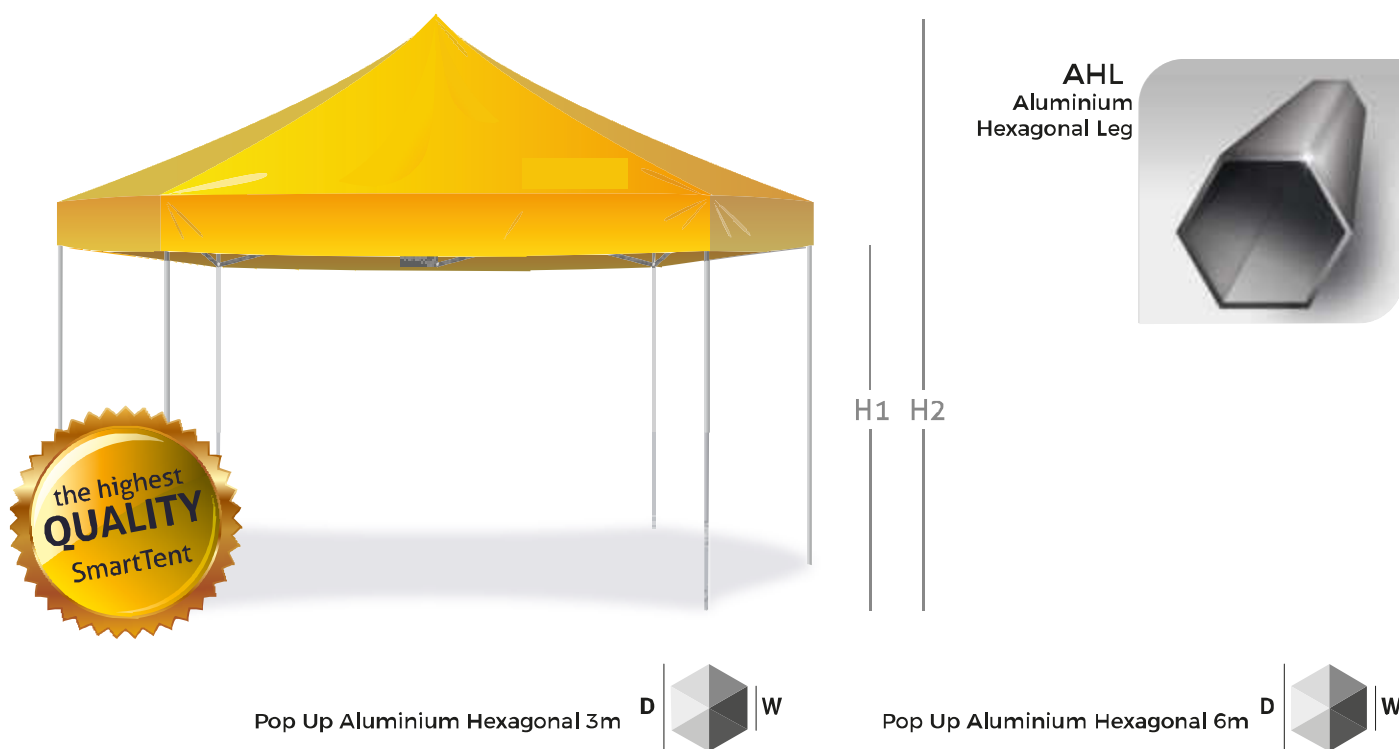

Size D*	305cm	590cm
Size W*	150cm	290cm
H1	196cm	196cm
H2	314cm	349cm

* size and dimensions given refer only to the most common tent specifications. Usually, tent height can be regulated by self-locking system. Please inform Studio55 about any special requirements regarding the tent height before we print the sidewalls.

* Die angegebenen Abmessungen/Höhen sind die Standard Voreinstellungen des Zeltes. Die Höhen können durch ein Druckknopfsystem individuell eingestellt werden. Wenn Sie die genauen Höhen erfahren möchten oder Sonderwünsche diesbezüglich haben, informieren Sie sich bitte bei BAS-Innovation bevor die Seitenwände des Zeltes in den Druck gehen.

Additional equipment

Zubehör

1. Marquise, Markise
2. Marquise MULTI, Markise MULTI
3. Sidewall MINI, Wände MINI
4. Rain gutter-connector, Regenrinne / Verbinder
5. Tent connector, Zeltverbindungsstück
6. FLag holder, Fahnenhalterung
7. Weight 5kg, Gewicht 5kg
8. Weight 20kg, Gewicht 20kg
9. Tent carry bag with wheels "Professional", Transporttasche auf Rollen "Professional"
10. Pegs, Heringe

B A S



Driven by Innovation

PopUp Aluminium Hexagonal (AHL) tents sidewalls

Wände zu Pop Up Aluminium Hexagonal Zelten (AHL)

Pop Up Aluminium Hexagonal 3m

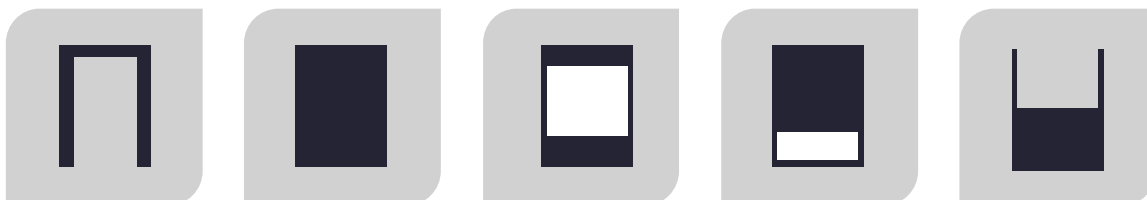

A

B

C

D

E

Pop Up Aluminium Hexagonal 6m

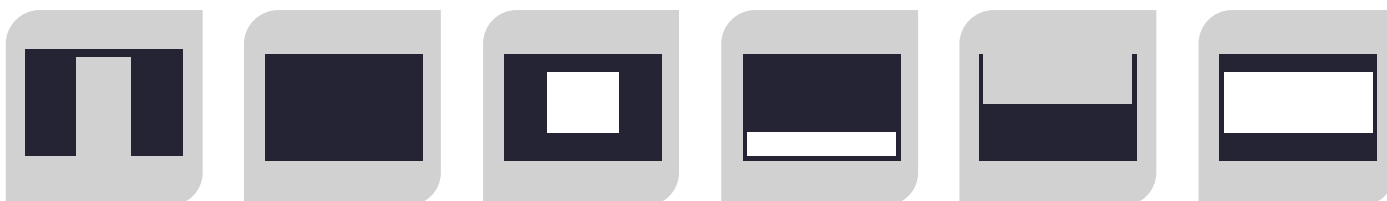

A

B

C

D

E

F

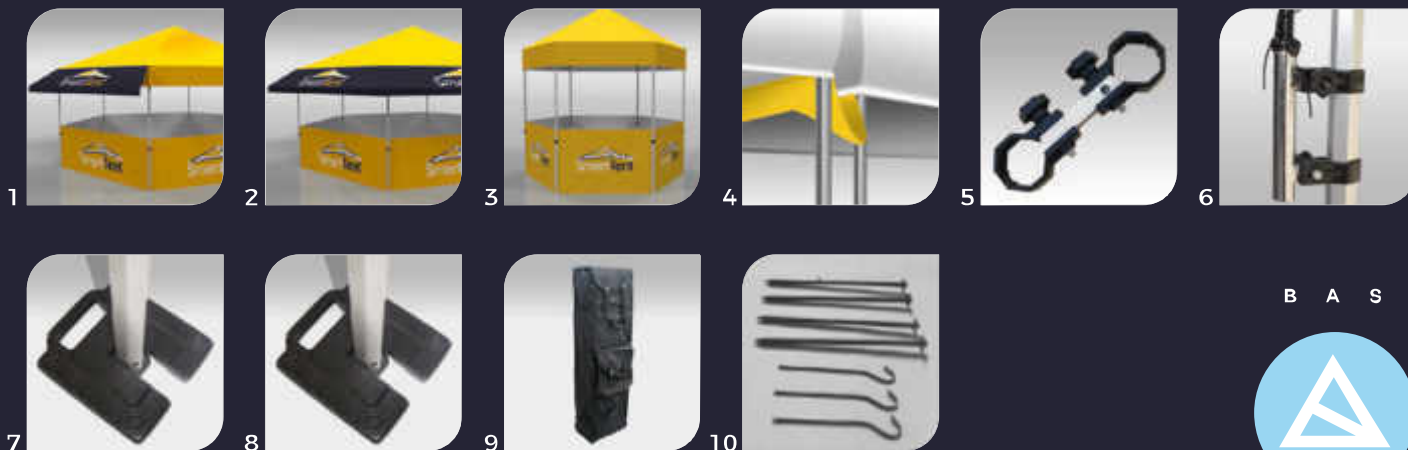

B A S



Driven by Innovation

Ergonomic Tent Floor

Ergonomischer Zeltboden

B A S



Driven by Innovation

Thanks to utilizing light, but also durable materials to create the all-new type of ergonomic tent floor, we have developed two types of tent flooring systems which provide functional aesthetics and are easy to keep clean. The products we came up with were exactly what we aimed for while designing our all-new tent floor SmartTent.

Durch die Verwendung sehr leichter und gleichzeitig auch sehr robuster Materialien, wird ein fantastischer Effekt erreicht: die Böden der Faltzelte sehen sehr ästhetisch aus und sind zudem sehr leicht sauber zu halten. Diese Punkte waren bei der Gestaltung der Böden für unsere neue SmartTent Serie das Wichtigste.

Square Floor Panel

Quadratische Bodenplatten

Dimension
A: 50cm

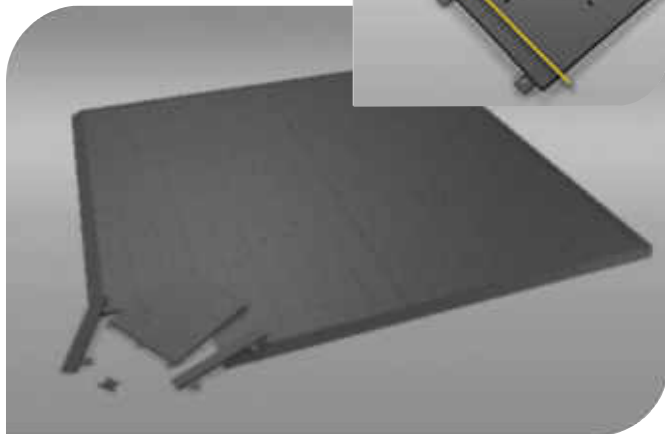
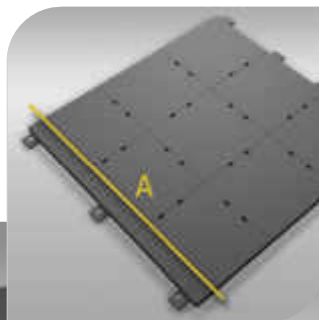

Honeycomb Floor Panel

Bienewaben Bodenplatten

Dimension
A: 27,5 cm / B: 47,8cm / C: 55cm

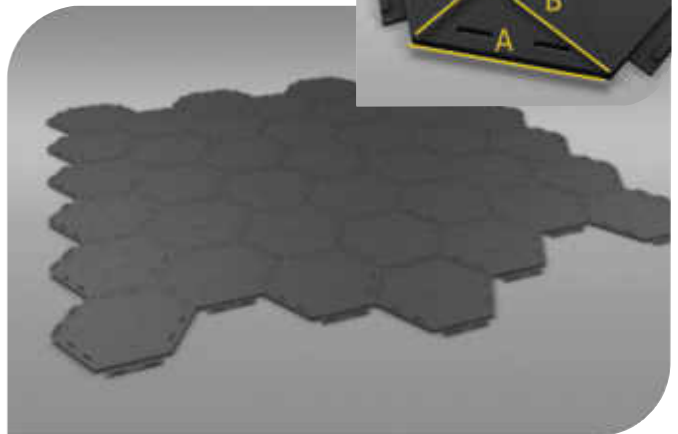
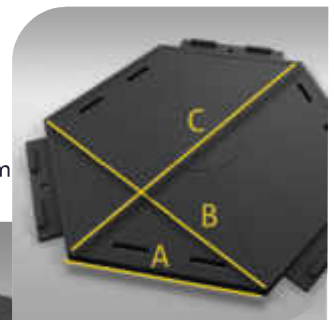

Custom floor covering matching the requirements of every campaign

Individuelle Bebauungen, angepasst an die Anforderungen der Kampagne
Indywidualne zabudowania dopasowane do wymogów każdej kampanii



B A S



Driven by Innovation

BAS Produktions- und Handels- GmbH
Karlsrufer Str. 50, 88069 Tettang
Tel. +49 (0)751 768 70 201
E-Mail: info@bas-innovation.de