

FLATCUBE REGALSYSTEM

Nicht enthalten:

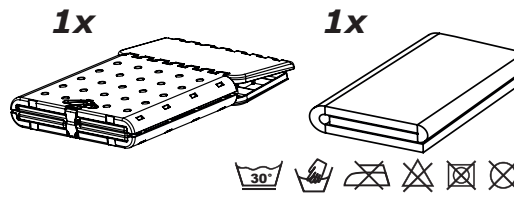

Nicht enthalten:



**WICHTIG: FÜR SPÄTERE
BEZUGNAHME AUFBEWAHREN.
SORGFÄLTIG LESEN.**

Der Flatcube ist DIN EN581 zertifiziert und für den Objektbereich zugelassen. **BAS Produktions- und Handels- GmbH** übernimmt keine Haftung für Schäden, die durch Überladung und nicht sachgemäßen Aufbau entstanden sind.

FLATCUBE

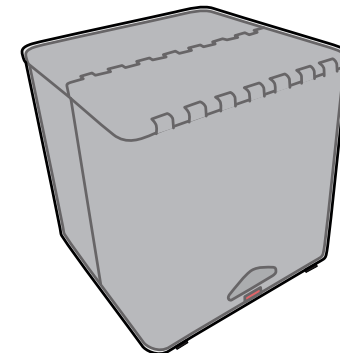

BAS Produktions- und Handels- GmbH
Untere-Breite-Str. 23
88212 Ravensburg / Germany

DE Patent Pending

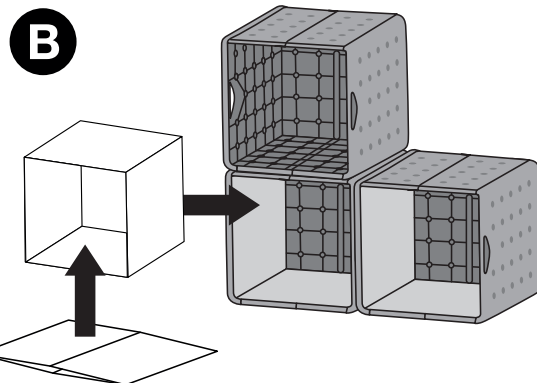
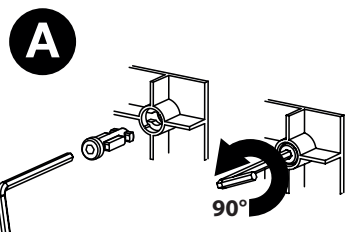

Achtung:
Es dürfen maximal 3 Flatcubes
übereinander angebracht werden!

Die Flatcubes lassen sich je nach Anzahl beliebig zu einem Regalsystem kombinieren.

Achten Sie beim Aufbau des Flatcube Regalsystems auf einen ebenen Untergrund und eine stabile Auflage der Flatcubes. Sichern Sie jeden Flatcube mit den dafür vorgesehenen 4 Steckelementen.

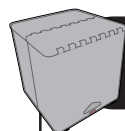

FLATCUBE inkl. Stoffüberzug

A Würfel in den
Überzug stellen

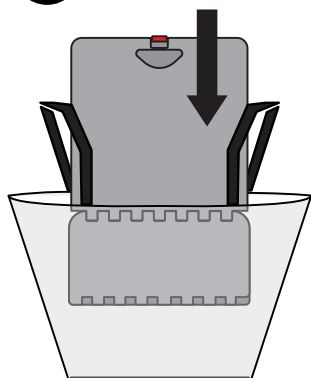

Mittig
platzieren

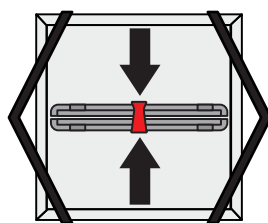

B Bänder
aufziehen

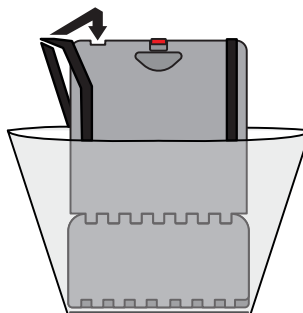

C Lasche
aufklappen



Cube 90%
öffnen

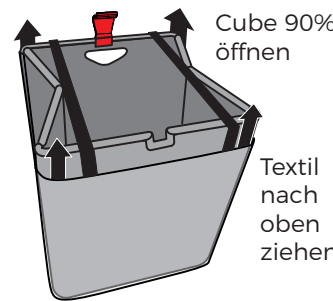

D

Lasche
einklappen



Cube 100%
öffnen

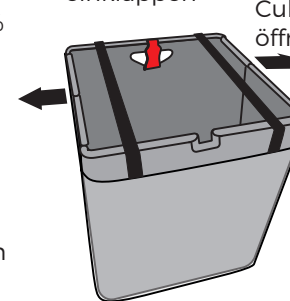

E

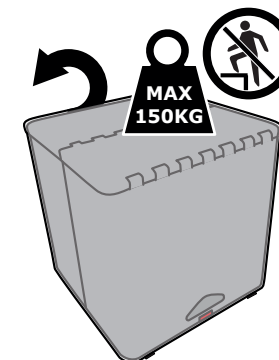

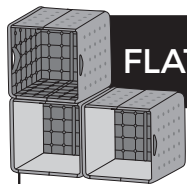

FLATCUBE shelf system

not included:

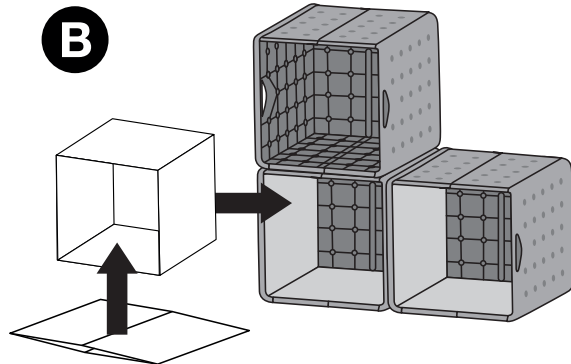
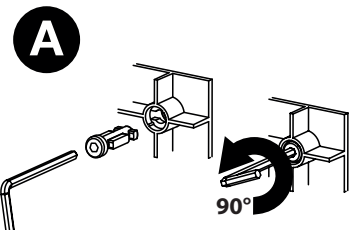
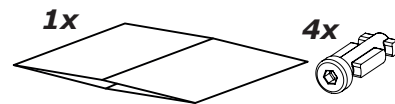

Warning:
No more than 3 Flatcubes are to be piled on top of one another.

The Flatcubes can be combined and interconnected to a shelf system depending on the requirements and number of Flatcubes.

Take care, that during installation there is a smooth and level underground and the Flatcubes have a stable base. Secure all Flatcubes with the provided 4 connector elements.

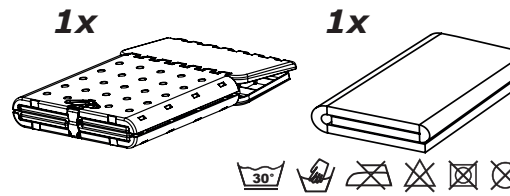

not included:

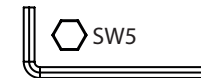

IMPORTANT: KEEP THESE INSTRUCTIONS IN A SAFE PLACE FOR FUTURE REFERENCE. PLEASE READ CAREFULLY.

The Flatcube is DIN EN581 certified and is approved for the contract sector. BAS Produktions- und Handels- GmbH accepts no liability for damages of any kind incurred by the customer through excess load or inappropriate handling.

FLATCUBE

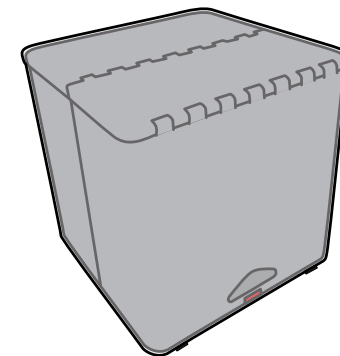

BAS Produktions- und Handels- GmbH
Untere-Breite-Str. 23
88212 Ravensburg / Germany

EN Patent Pending

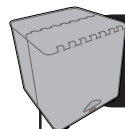

FLATCUBE incl. textile cover

A put cube in cover

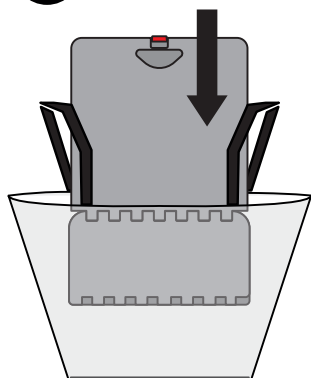

place centered

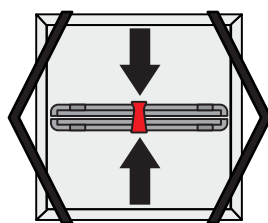

B mount elastic straps

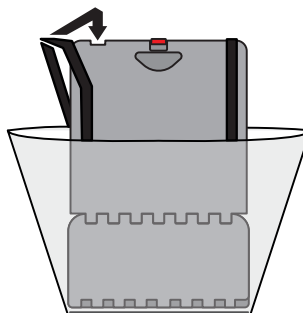

C open clamp

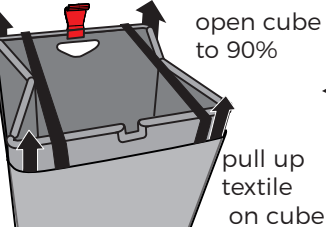

D close clamp

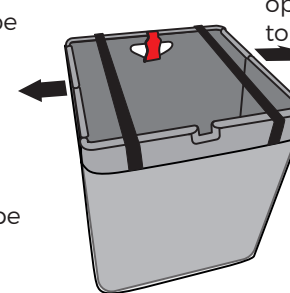

E

